



# Investor Presentation

**December 2019**  
**NASDAQ: MOSY**

# Safe Harbor Statement

This presentation may contain forward-looking statements about MoSys, Inc. (the Company) for purposes of Section 27A of the Securities Act of 1933, as amended, and Section 21E of the Securities Exchange Act of 1934, as amended, including, without limitation, benefits and performance expected from use of its embedded memory and interface technologies and integrated circuit (IC) products, improving operational efficiencies, the timing of product development and shipments of the Company's IC products, anticipated benefits and performance expected from the Company's IC products, growth in the size of the market addressed by the Company's business, future markets and future business prospects. Forward-looking statements are based on certain assumptions and expectations of future events that are subject to risks and uncertainties. Actual results and trends may differ materially from historical results or those projected in any such forward-looking statements depending on a variety of factors. These factors include, but are not limited to the following:

- ❖ a lack of working capital to aggressively fund product development and growth;
- ❖ achieving additional design wins for our IC products through the acceptance of our IC architecture and interface protocols by potential customers and their suppliers;
- ❖ the timing of customer orders and product shipments;
- ❖ customer concentration;
- ❖ lengthy sales cycle;
- ❖ our ability to enhance our existing proprietary technologies and develop new technologies;
- ❖ achieving necessary acceptance of our IC products by equipment suppliers to the cloud networking, data center, security and other systems markets;
- ❖ difficulties and delays in the development, production, testing and marketing of our IC products;
- ❖ reliance as a fabless semiconductor manufacturer on our manufacturing partners to assist successfully with the fabrication of our ICs;
- ❖ availability of quantities of ICs supplied by our manufacturing partners at a competitive cost;
- ❖ ability to make our new software acceleration and IP products commercially available and achieve customer acceptance of these new proprietary technologies;
- ❖ level of intellectual property protection provided by our patents, the expenses and other consequences of litigation, including intellectual property infringement litigation, to which we may be or may become a party from time to time;
- ❖ vigor and growth of markets for cloud networking, data center, security and other systems served by our licensees and customers;  
and

other risks identified in MoSys' most recent reports on form 10-K and form 10-Q filed with the Securities and Exchange Commission, as well as other reports that MoSys files from time to time with the Securities and Exchange Commission. MoSys undertakes no obligation to update publicly any forward-looking statement for any reason, except as required by law, even as new information becomes available or other events occur in the future.

# About MoSys

❖ **Silicon Valley fabless semiconductor company providing Silicon devices and software/firmware IP**

• **Silicon Accelerator Engine Intelligent Memory ICs**

- High-speed serial attached memories for FPGA applications
  - Patented Serial high-speed Interface (signal connections)
  - Intelligent In-Memory functions



• **New... Software Solution Function Platforms**

- High Value, High Level Application Functions
- Software Products & FPGA Firmware IP (Intellectual Property)
- Portable Functions across range of Performance-Scaled Hardware

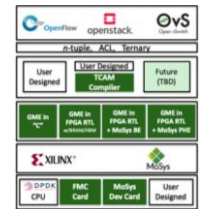

• **High-Speed PHY (Serial Signal) IC products**

- Signal conditioning, Gearbox, Retimers

• **Products are Market/Customer performance validated**

- Palo Alto Networks, Nokia, Fujitsu, etc.



NASDAQ: MOSY  
 ISO 9001:2008 Certified  
 HQ: San Jose, CA  
 ~115 Patents & Pending

**Acceleration options Not available in any other competing product**

# Silicon Accelerator Engine Memory ICs

## Packet / Data Processing Cards

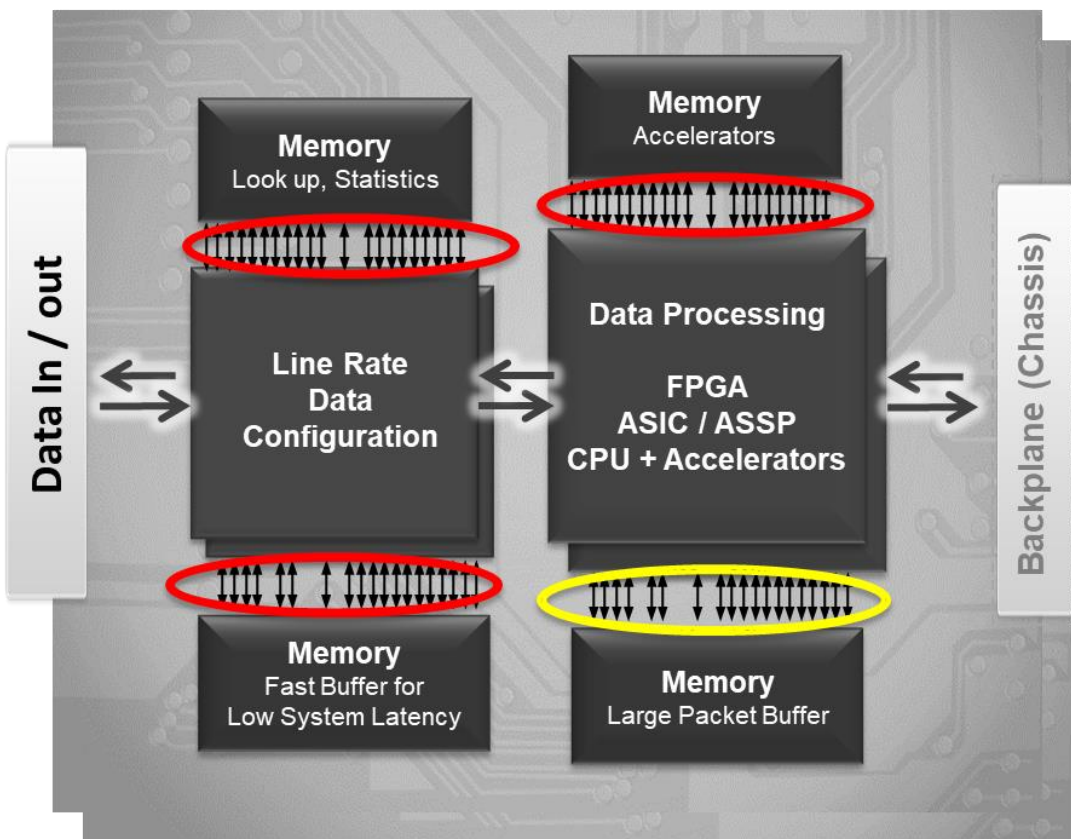

### Data Processing Card Functions:

Router, Switch, Security, Monitor/Test, Video, Server Offload

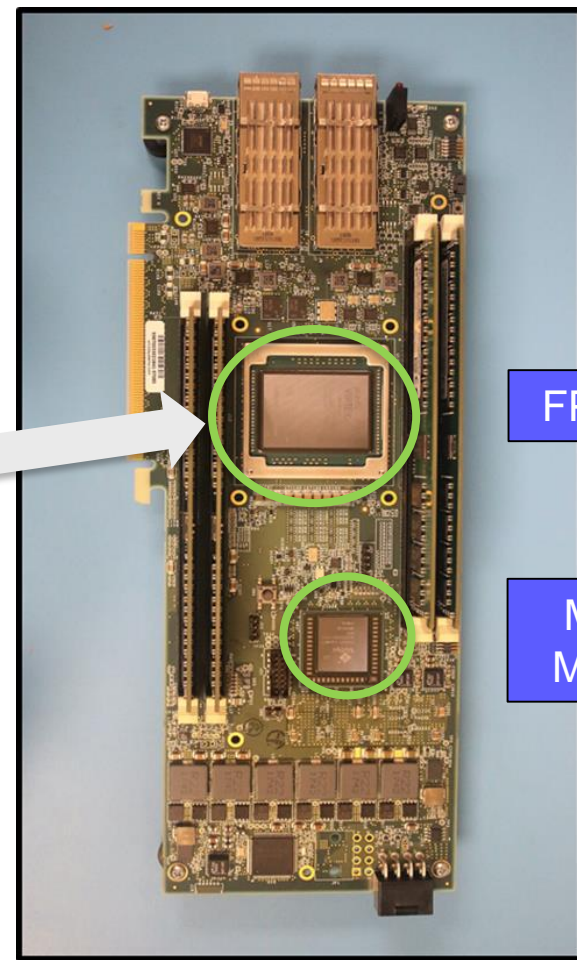
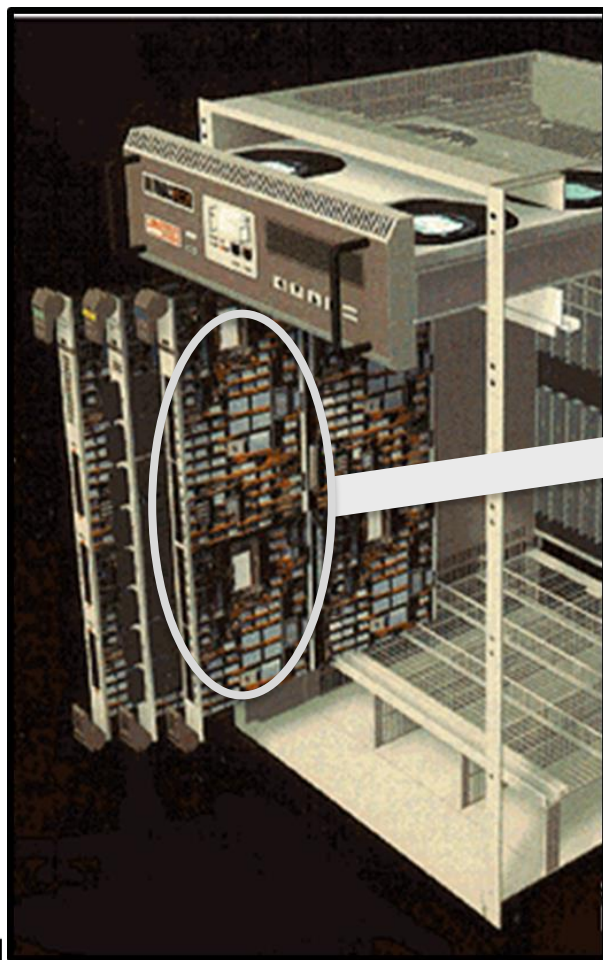

FPGA

MoSys  
Memory



# Typical High-Volume Accelerator Cards

**INPUT & OUTPUT**



**DRAM**



**FPGA**

(Field Programmable Gate Array)



**New - MoSys Software Platform Embedded in FPGA**

**MoSys High-Speed Memory Serial attached to the FPGA**

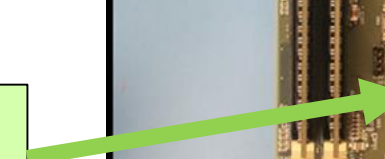

**POWER CONTROL**



# FPGA is a \$5B market for Intel (Altera) & Xilinx

## MoSys Accelerates FPGA Application Performance

### Intel/Xilinx FPGA

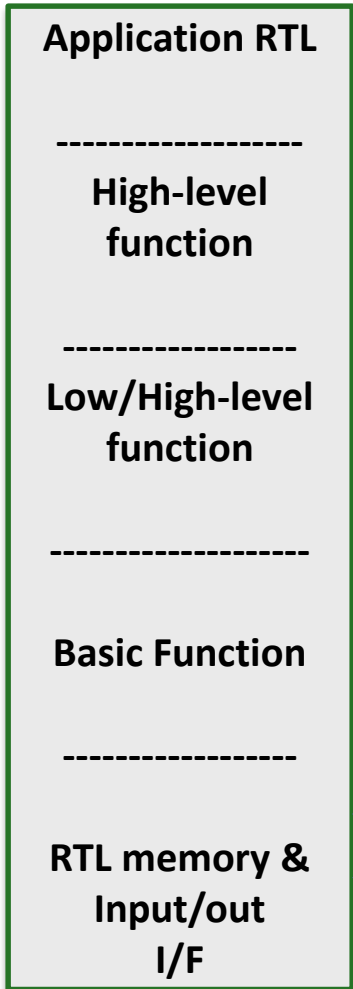

MoSys attaches to high-speed FPGAs

- Intel
- Xilinx

FPGA is reprogrammable!

- Logic is defined with FPGA RTL software
- Defines:
  - Logical flow of information & Control
  - Function execution
  - Data manipulation
  - Input/Output control
- **Most functions need external Memory**

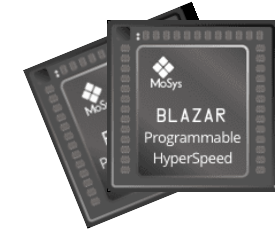
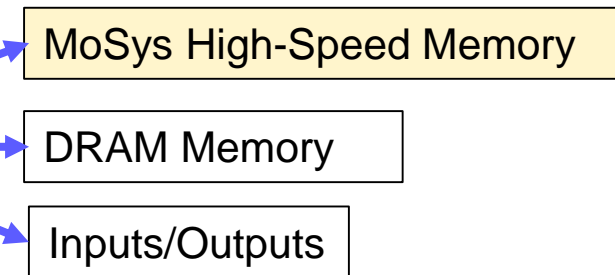

### BLAZAR Accelerator Engine IC Products (AE)

- Bandwidth Engine Silicon ICs
  - High-Speed serial attached memories
  - Large memory sizes
    - 512Mb
    - 1Gb
  - Differentiated by In-Memory
    - Intelligent functions
- Programmable HyperSpeed Engine IC
  - Bandwidth Engine with 32 computer cores

# Saves Space/Cost

## Serial vs Parallel Memories

### QDR (Memory Competitor) Parallel Connection

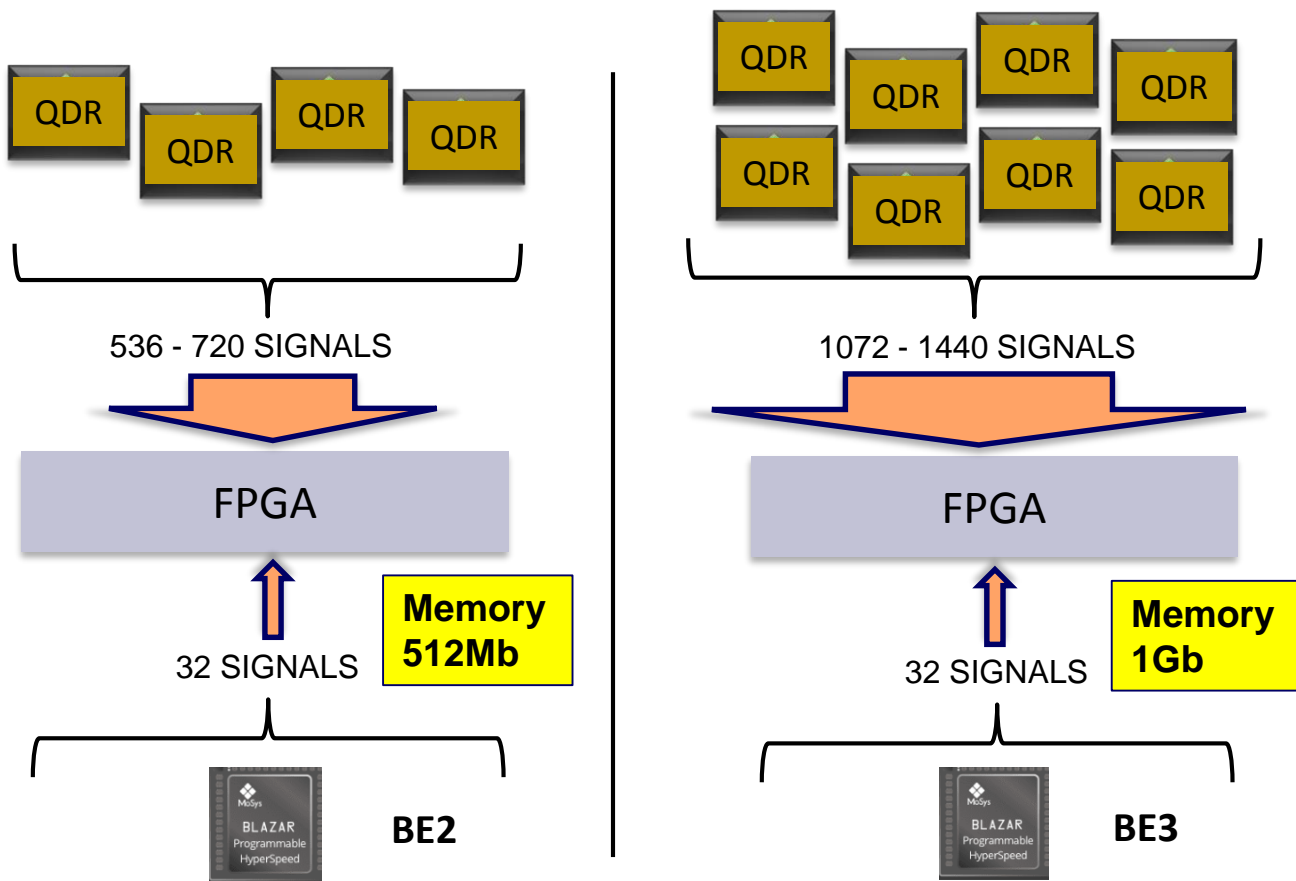

### MoSys Bandwidth Memory Serial Connection

### Space & Cost Considerations

#### Performance Balance of Memory vs Space

- Space
  - BE2 = 4 QDR ... 512Mb
  - BE3 = 8 QDR ... 1Gb
- Part Cost
  - 1-BE2 for 512Mb memory ~ 2x cost of one QDR
    - 4x Memory
  - 1-BE3 for 1Gb memory ~ 2.5x cost of one QDR
    - 8x Memory
- Design time
  - Signal routing time and layout
  - Told it saved 6-9 months
- Signal Integrity
  - 536-1440 clean signals
    - External components
  - MoSys on board signal tuning
    - No external components
- Power
  - ~ Half
- Bandwidth
  - Random data access is equivalent
  - For certain applications, much faster

# MoSys Intelligent Serial Memory

For Networking to Testers to Video to IOT... when speed is key!

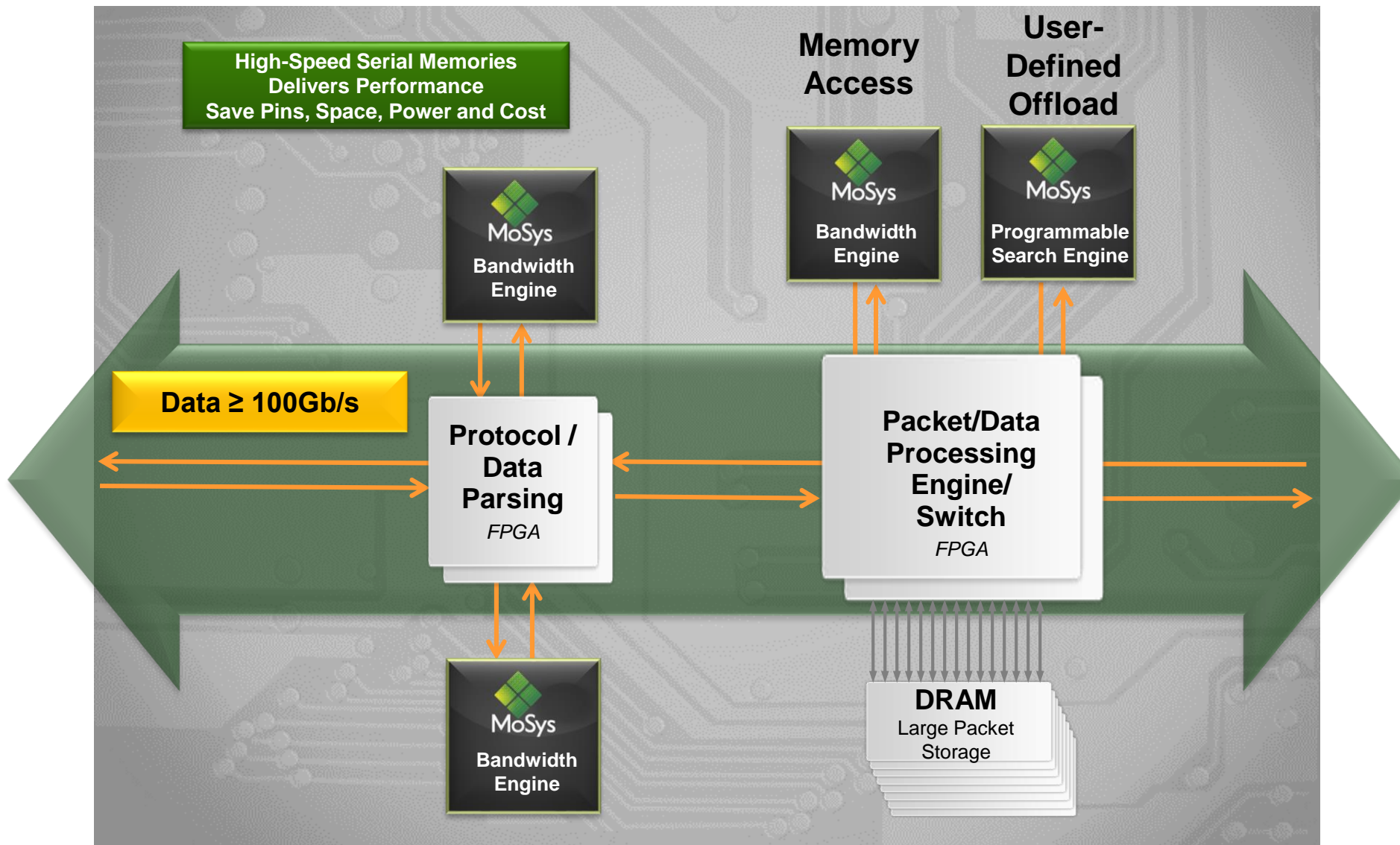



# Acceleration with MoSys In-Memory Execution

## CURRENT

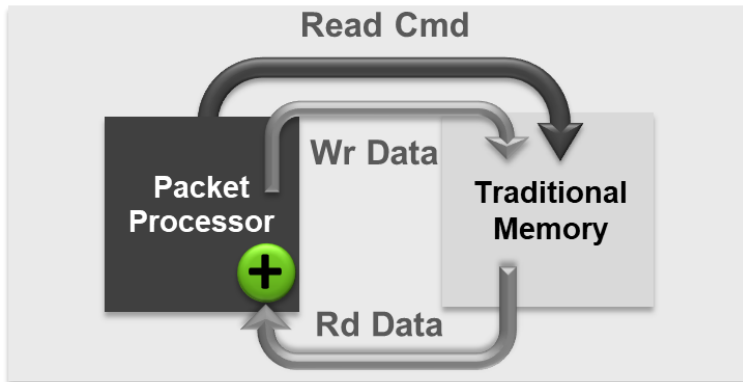

## MoSys IN-MEMORY

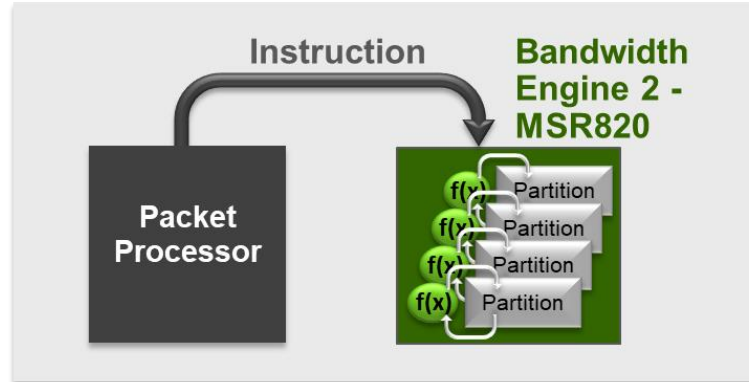

## MoSys In-Memory Functions

Standard in all MoSys ICs

- BURST
  - Multiple Sequential READS
  - Multiple Sequential WRITES
  - Function types ~12
- RMW (Read-Modify-Writes)
  - ADD, SUB, INC, Compare, etc.
  - Functions ~17

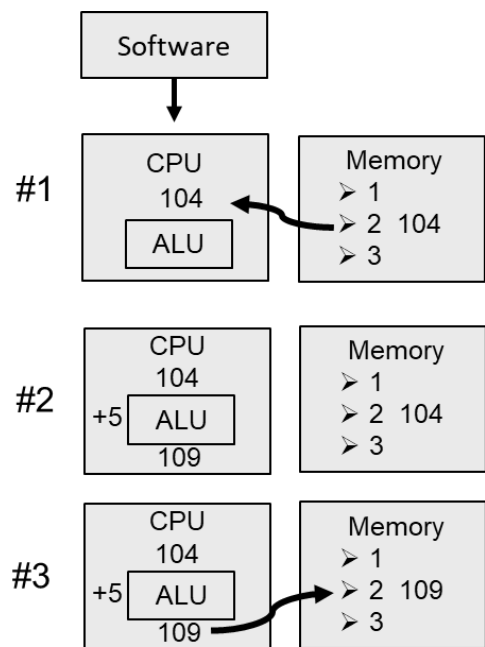

**FUNCTION:**  
ADD, 5 to Loc #2

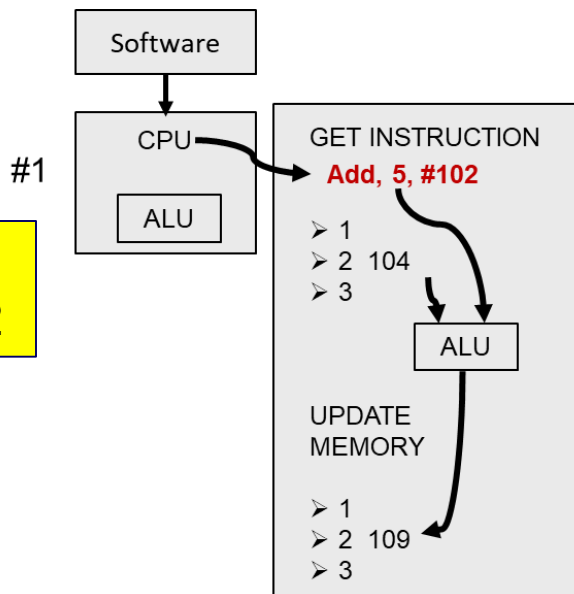

# Accelerating FPGA Applications with Speed & Intelligence

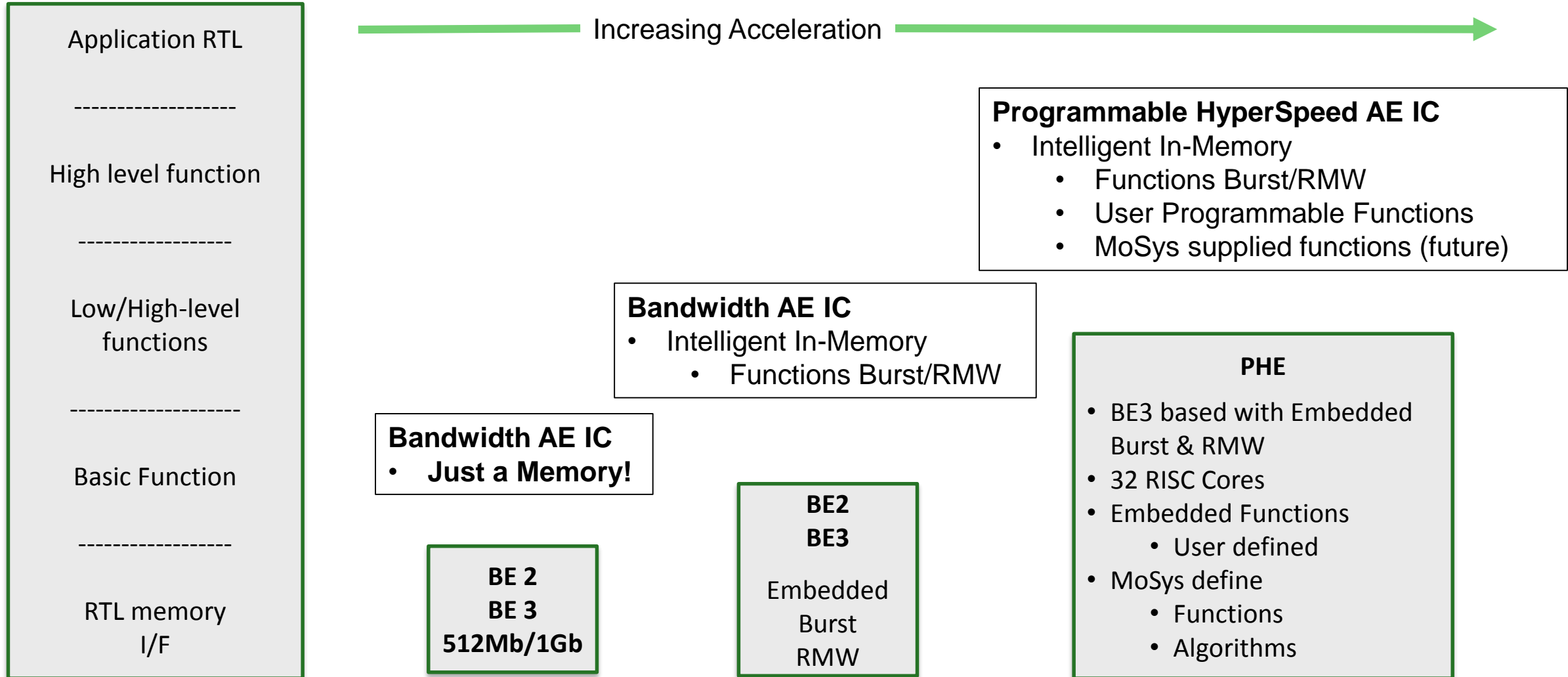

# MoSys Value Proposition

## Speed-Signals-Space-Cost

Bandwidth Engine relieves key system constraints

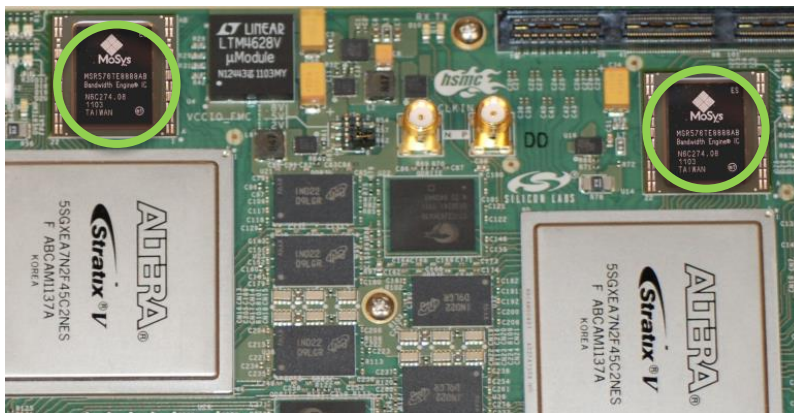

Attribute	Competition		MoSys Bandwidth Engine
	QDR	SRAM/ RLDRAM	
Speed	80-800Gb/s		
Number of Chips	4 - 8	4-8x more Memory	1
Pin Count (Signals)	526-1440	85-95% less Pins	32
Power (W)	14 - 28	~ 50% less power	8 - 16
Markets - Broad	Any High-Speed FPGA with Memories Attached		

Source: Company Management

# New...Virtual Accelerator Software Platforms

## Capturing more dollar value of the solution!

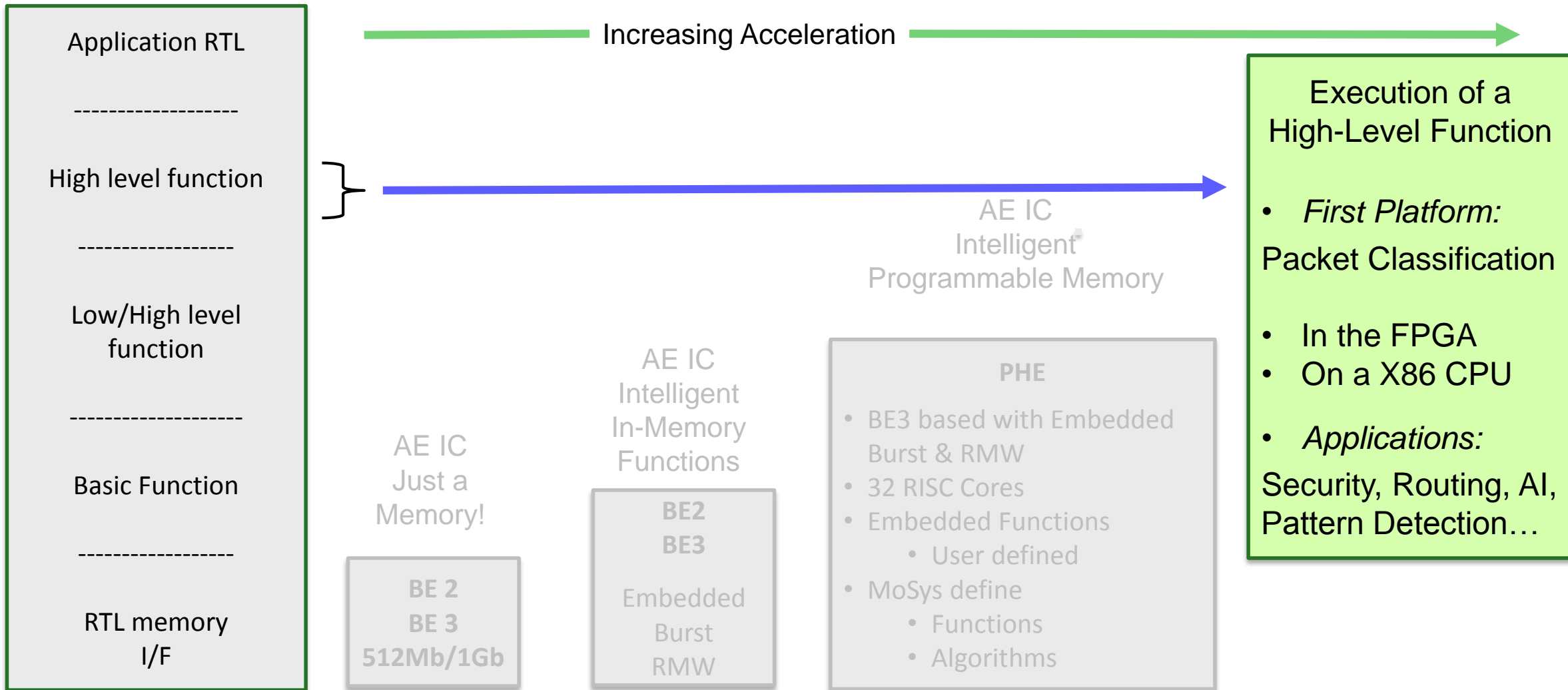

# Virtual Accelerator Engine Platform

## Software Portability – Scalable Agnostic Hardware

- Software Goal: Software Portability

- Common API
  - Application Programming Interface
  - Set of Instructions

- Hardware Goal: Hardware Agnostic

- Common RTL Interface
  - FPGA Code
  - Performance Scalable Hardware Solutions

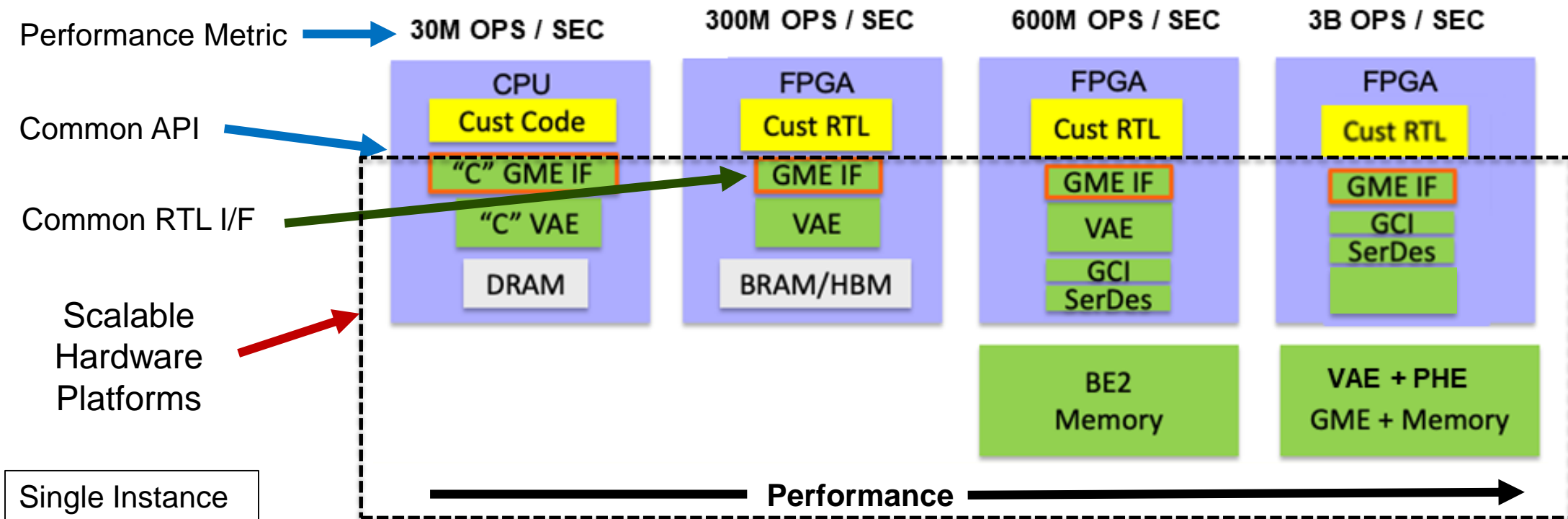



# VAE – Software and FPGA IP

## SOFTWARE ONLY

30M OPS / SEC

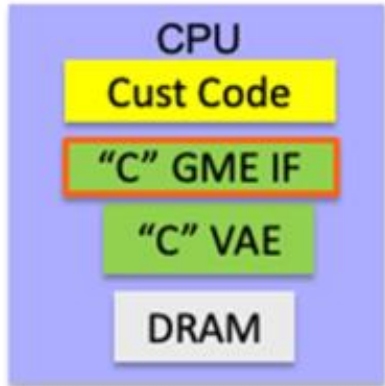

### Characteristics

- Runs on any X86 system
- Software Only

### Implementation

- Use S/W API
- Existing systems Acceleration

## FPGA RTL – IP in the FPGA

300M OPS / SEC



### Characteristics

- *10x over Software Only*
- Does not require MoSys AE ICs

### Implementation

- Embedded IN THE FPGA
- Uses API and RTL
- Existing systems Acceleration

## KEY POINTS

- MoSys NOW offering Software and IP products - *NEW* Revenue Stream
- Does not require MoSys Silicon Accelerator Engines ICs
  - BE2/3 or PHE
- Works with Existing Hardware designs
- Short time to Revenue --- Design License (Up Front) – Use License per system

# VAE – FPGA with Accelerator Engine ICs

## FPGA with Bandwidth Engine (BE)

600M OPS / SEC

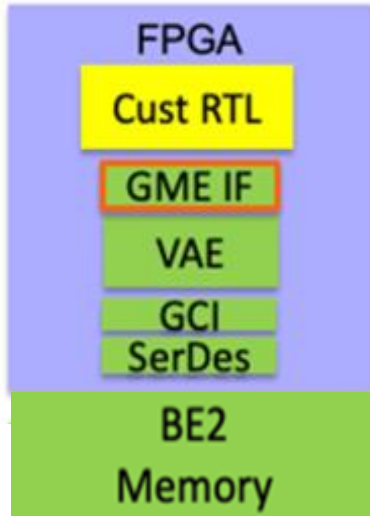

### Characteristics

- 2X the performance of FPGA only
- GME located in FPGA
- Uses AE High Speed Memory

### Implementation

- Requires hardware design

## FPGA with Programmable HyperSpeed Engine

3B OPS / SEC

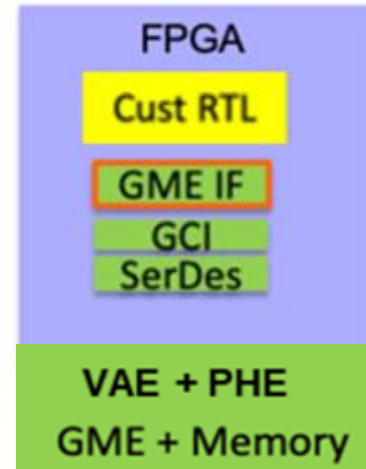

### Characteristics

- 5X the performance of BE
- 100X the Software only
- Uses PHE – Memory/32 CPUs
  - GME located in PHE
- Extreme Acceleration

### Implementation

- Requires hardware design

## KEY POINTS

- Much Higher Performance WITH Bandwidth Engine IC
- “HyperSpeed” Acceleration with Programmable HyperSpeed Engine IC
- Short time to Revenue --- Design License (Up Front)
- Delayed Revenue --- Use License per system

# First ...Packet Classification Platform

## Software Portability – Hardware Agnostic

Applications: Security, Routing, AI, Pattern Detection...

- Software Goal: Software Portability
  - Designers determine Software performance required
- Hardware Goal: Scaled performance hardware solutions
  - Hardware environment is selected

### “SOFTWARE DEFINED/HARDWARE ACCELERATED”

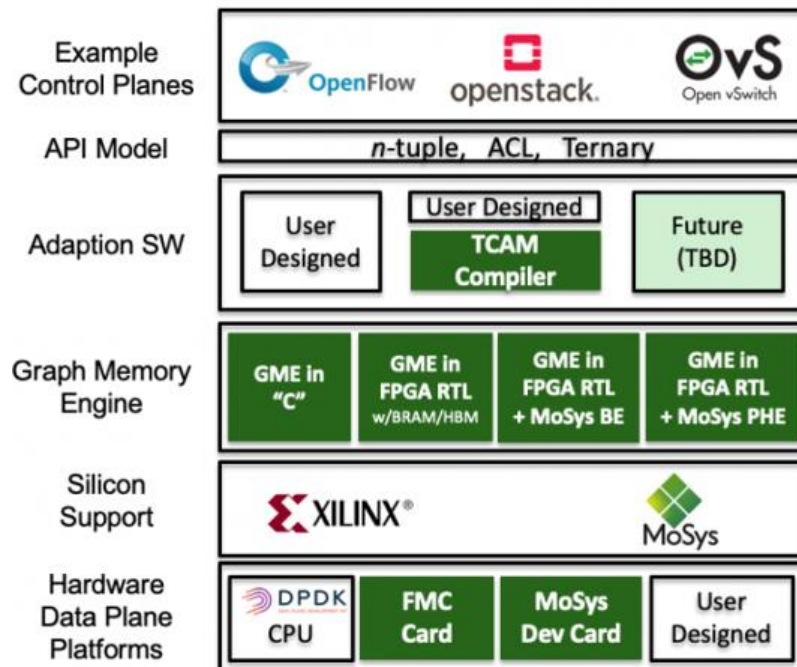

### MoSys Software & Firmware IP

- **Potential New Revenue Streams**
- **New Markets and Applications**
- *NOT dependent on using MoSys AE ICs*
- Legacy Systems -- No H/W redesigns required
- New BE H/W designs --High Acceleration

### Short time to revenue

- License – Upon engagement
- Royalty Use – Implementation
  - Add to Existing systems
    - Reprogram the FPGA
    - Quick Time to Market
- Current customer engagements

**GME = Graph Memory Engine will Support new Future Platform!**

# Accelerator Engine Product Lines

## IC Accelerator Engines (AE)

**Target Performance Based---**  
**Point Products**

### Bandwidth Engine



BE2 Family based with 512 Mb memory

BE3 Family based with 1Gb memory

In-Memory Acceleration Functions

- Burst (12+)
- RMW with ALU (17+)

### Programmable HyperSpeed Engine

#### PHE

- BE3 with 1Gb memory
- 32 CPU cores
- In-Memory Functions  
Burst/RMW
- Use defined functions
- Future MoSys embedded functions

## Virtual Accelerator Engines (VAE)

**Software Portability Based---**  
**Solution Products**

Virtual Accelerator Engines- GME  
API Software Based



### First - Packet Classification Platform

\*Common API

- Transportable software
- Family of products

\*Common RTL

- Scalable performance
- Selectable Hardware

Product/Application (*Stacking*) can be

- Software only
- RTL (FPGA) (*New & Existing designs*)
- RTL(FPGA) with BE2 or BE3
- RTL (FPGA) with PHE

## Dev/ Ref boards

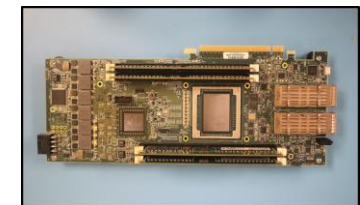

- Cheetah Xilinx PCIe
- FMC Dev Card

# Expanding Market Opportunities

**New Markets Requiring Bandwidth & Access Performance**

**Existing Roadmap Addresses Growing Markets**

- Leading edge performance
- Future optimizations in software

**Long Product Life: 5-10 Years**

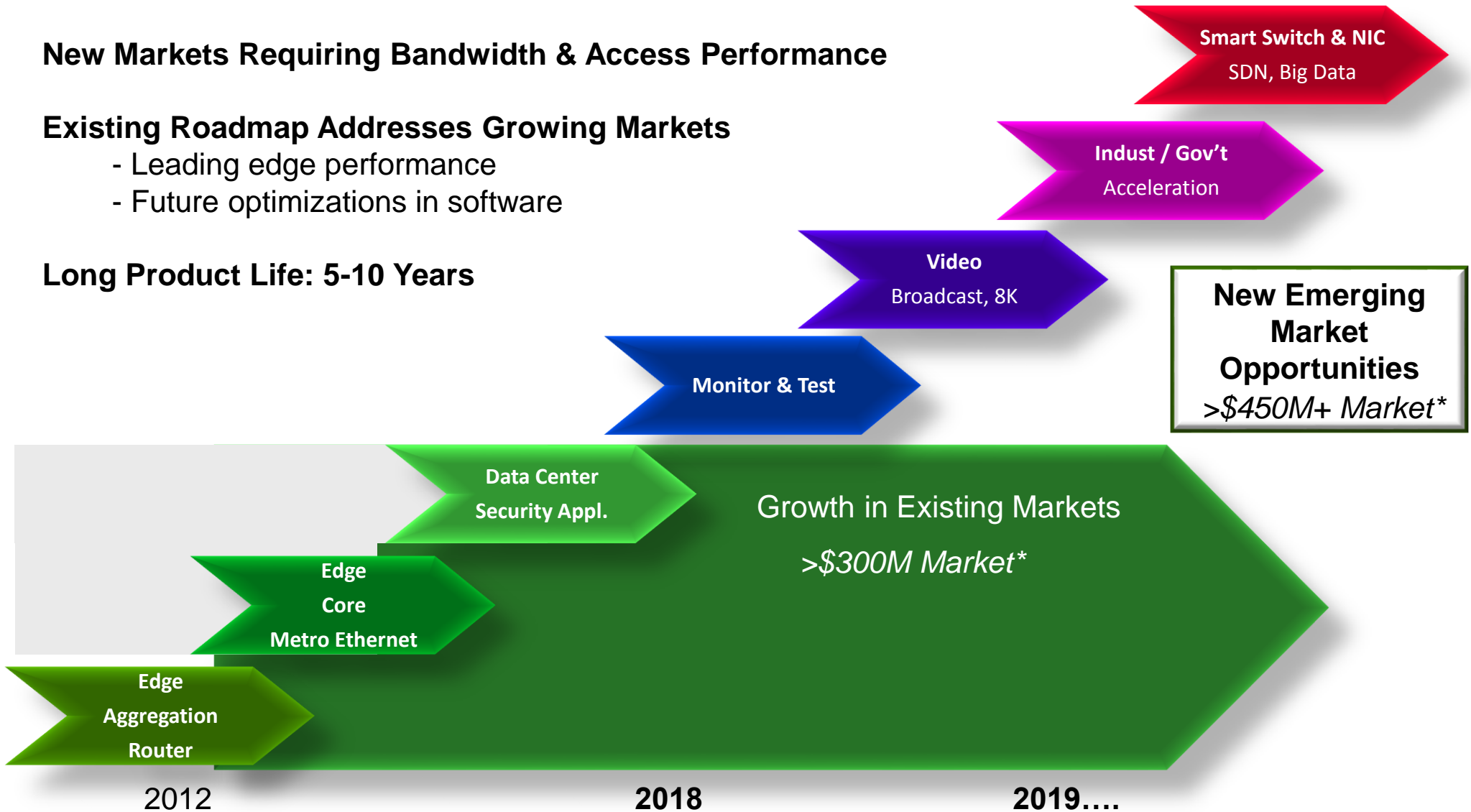

\* Market definition and other information is based on management opinion.



# LineSpeed™ 100G PHY Products

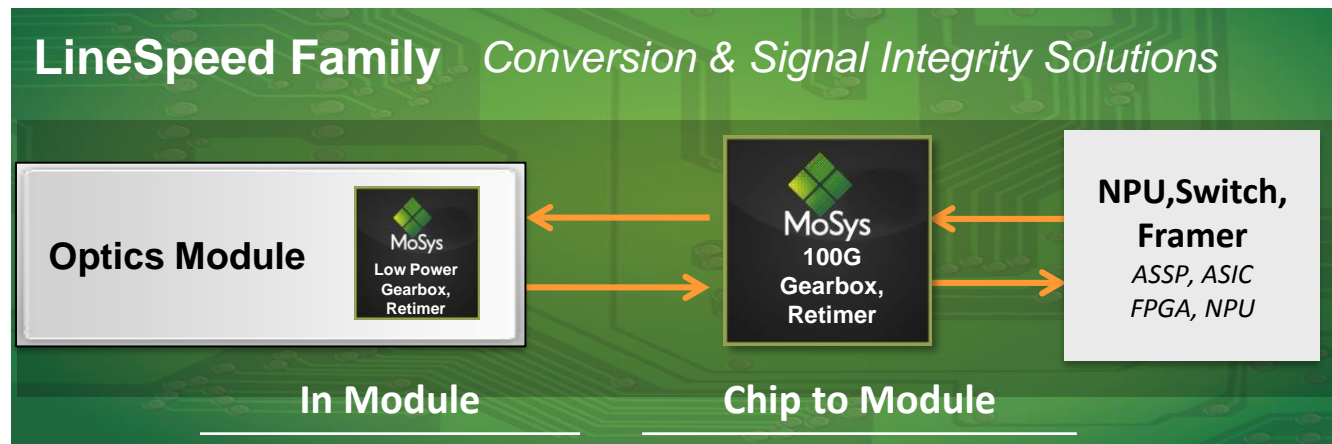

**LineSpeed PHY Family**

MSH321 (S)  
100G MLG Gearbox

MSH221 (S,F)  
100G Octal Retimer w FEC

MSH320  
100G Gearbox w/FEC

MSH322  
MLG Gearbox

MSH225  
10 Lane Full Duplex Retimer

MSH222  
100G FD Quad Retimer w/FEC

- ❖ **Industry-standard interfaces**
- ❖ **Flexible Gearbox, Retimer and FEC functions**
- ❖ **Strong signal Integrity**
- ❖ **Low-power options**

## Experienced Management Team

**Dan Lewis**

CEO



**Jim Sullivan**

CFO



**Gus Lignos**

VP Sales



**Michael Miller**

CTO



**Sinan Doluca**

VP Engineering & Operations





# Summary Income Statements

\$ in millions, except EPS

Non-GAAP*	2018	1Q 19	2Q 19	3Q 19	YTD2019
Total Revenue	\$ 16.6	\$ 3.5	\$ 3.1	\$ 1.2	\$ 7.8
Product	\$ 15.1	3.4	2.8	1.0	7.2
Royalty/other	1.5	0.1	0.3	0.2	.6
Product GM %	58%	60%	59%	61%	60%
Total GM %	62%	62%	60%	66%	62%
R&D	3.7	1.2	0.9	1.1	3.2
SG&A	3.7	0.9	0.9	1.0	2.8
Total Op Ex	7.4	2.1	1.8	2.1	6.0
Op Income (loss)	2.8	-	-	(1.3)	(1.2)
Net Income (loss)	\$ 2.2	\$ -	\$ -	\$ (1.3)	\$ (1.3)
Adjusted EBITDA**	\$ 3.4	\$ 0.1	\$ 0.1	\$ (1.2)	\$ (1.0)
EPS (basic)	\$ 0.15	\$ -	\$ -	\$ (0.60)	\$ (0.59)

## Key Initiatives:

- ❖ Establish Sales & Operational Scale
- ❖ Achieve/Maintain Profitability
- ❖ Reduce Cash Burn
- ❖ Improve Cash Position

\* Non-GAAP: Excludes stock-based compensation, amortization of intangibles and restructuring/impairment charges. See reconciliation of GAAP to non-GAAP results on slide 22.

\*\* Adjusted EBITDA defined as GAAP net income (loss) before interest expense, income tax provision, depreciation and amortization, as well as stock-based compensation, intangible asset amortization and restructuring/impairment charges. See reconciliation of GAAP to non-GAAP financial information on slide 21.

## Balance Sheet

	<b>Q3 - September 30, 2019</b> <i>(in millions)</i>
	<b>Actual</b>
<b>Cash</b>	<b>\$6.8</b>
<b>Total Assets</b>	<b>\$10.1</b>
<b>Deferred Revenue</b>	<b>\$0.1</b>
<b>Convertible Notes* (Long-Term)</b>	<b>\$2.9</b>
<b>Total Liabilities</b>	<b>\$4.6</b>
<b>Stockholders' Equity</b>	<b>\$5.5</b>
<b>Total Shares Outstanding</b>	<b>2.2</b>

\* Key terms: i) Interest rate 8% (PIK at company's option), ii) Convert price - \$11.40 per share, iii) \$2.9M due in full in August 2023 and iv) no covenants

- ❖ **History of impacting markets with unique products/IP**
- ❖ **Product portfolio has major customer validation**
- ❖ **Highly-differentiated products with attractive gross margins**
  - High ASP and high-margin products
  - Limited competition
  - Proprietary products build long-term partnerships
- ❖ **Sales & Marketing focused on expansion**
  - Sales Channels
  - Into Large New Markets
  - Into New Applications
- ❖ **Best of both worlds... Hardware and 'now' Software**
  - Silicon IC based Accelerator Engine for Broad Markets...High margin
  - Software Platforms --- Potential New Revenue Stream of Software & Firmware IP
    - Target for specific solutions high value performance solutions
    - Does not require MoSys ICs...Higher performance with MoSys ICs
    - Shorter time to Revenue...Target Model - License Design/Use Royalty



*Accelerator Products:  
Fast, Intelligent Solutions*





**Thank You**

Dan Lewis  
President & CEO  
408-418-7581  
dlewis@mosys.com

Jim Sullivan  
Chief Financial Officer  
408-418-7582  
jsullivan@mosys.com



## Reconciliation of GAAP and Non-GAAP Financial Information

*\$ in 000s*

	2018	1Q 19	2Q 19	3Q 19	YTD 2019
<b>GAAP net income (loss)</b>	(\$ 11,410)	\$ 10	(\$ 103)	(\$ 1,801)	(\$ 1,894)
Stock-based compensation expense	675	(4)	119	84	199
Restructuring & impairment charges	12,856	-	-	420	420
Amortization of intangibles	112	-	-	-	-
<b>Non-GAAP net income (loss)</b>	2,233	6	16	(1,297)	(1,275)
EBITDA adjustments:					
Depreciation	598	72	39	37	148
Interest expense	551	54	56	54	164
Provision (benefit) for income taxes	14	-	-	-	-
<b>Adjusted EBITDA</b>	\$ 3,396	\$ 132	\$ 111	(\$ 1,206)	(\$ 963)